

Standard Lengths : 2 Metres

Prices do not include 'C' Profiles.

For other sizes, grades or colours
consult our Technical department.

DISCOUNTS

1 - 9	List Price
10 - 49	- 20%
50 - 100	- 50%

without C Section Slots

PART NUMBER	Finished Size				PRICE PER METRE
	B	H	b	h	
TDCR5.0RM5	20	10	5.5	3.0	£43.86
TDCR6.3RM6	20	10	7.0	3.5	£43.86
TDCR8.0RM8	20	12	8.5	4.5	£45.35
TDCR9.5RM10	25	15	12.0	6.0	£50.27
TDCR12.5RM12	30	20	13.0	6.5	£58.33
TDCR15.0RM15	35	25	15.5	8.0	£68.04
TDCR18.0RM18	40	25	18.5	9.5	£72.20
TDCR20.0RM20	45	30	20.5	10.5	£84.39

with C Section Slots

PART NUMBER	Finished Size					C Profile	PRICE PER METRE
	B	H	b	h	Hc		
TDCR5.0RM50C	20	10	5.5	3.0	15.0	TDC 2010	£80.10
TDCR6.3RM60C	20	15	7.0	3.5	18.0	TDC 2010	£83.97
TDCR8.0RM80C	20	15	8.5	4.5	18.0	TDC 2010	£83.97
TDCR9.5RM100C	25	15	12.0	6.0	20.0	TDC 2812	£86.52
TDCR12.5RM120C	28	15	13.0	6.5	20.0	TDC 2812	£88.00
TDCR15.0RM150C	33	20	15.5	8.0	25.0	TDC 3818	£96.57
TDCR18.0RM180C	38	20	18.5	9.5	25.0	TDC 3818	£99.85
TDCR20.0RM200C	38	25	20.5	10.5	30.0	TDC 3818	£106.70

Materials

Belt Guides for V-Belts

STD : Polyethylene (U.H.M.W.Pe) Green DIN 2215

ALTERNATIVE : 1000 Black Antistatic

TDC

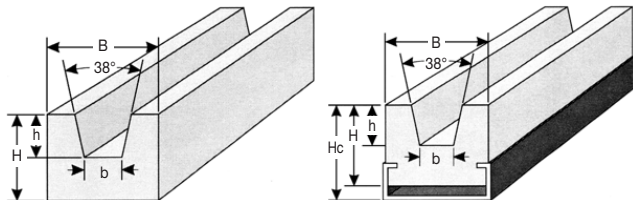

Standard Lengths : 2 Metres

Prices do not include 'C' Profiles.

For other sizes, grades or colours consult our Technical department.

without C Section Slots

DISCOUNTS

1 - 9	List Price
10 - 49	- 20%
50 - 100	- 50%

PART NUMBER	B	Finished Size			PRICE PER METRE
		H	b	h	
TDCR8F	20	10	5.0	3.5	£44.30
TDCR10Z	20	10	6.5	4.5	£44.30
TDCR13A	20	12	8.5	6.0	£44.30
TDCR17B	30	15	10.5	8.0	£44.30
TDCR20G	30	20	12.5	9.0	£59.23
TDCR22C	35	20	14.0	10.5	£62.60
TDCR25H	40	25	15.5	12.0	£73.19
TDCR32D	50	30	20.0	16.0	£90.34
TDCR40E	60	35	25.0	21.0	£111.04

with C Section Slots

PART NUMBER	B	Finished Size			C Profile	PRICE PER METRE
		H	b	h		
TDCR8FOC	20	10	5.0	3.5	TDC 2010	£82.05
TDCR10ZOC	20	15	6.5	4.5	TDC 2010	£82.05
TDCR13AOC	25	18	8.5	6.0	TDC 2012	£82.05
TDCR17BOC	30	18	10.5	8.0	TDC 2812	£82.05
TDCR20GOC	30	18	12.5	9.0	TDC 2812	£99.95
TDCR22COC	35	25	14.0	10.5	TDC 3818	£106.21
TDCR25HOC	40	25	15.5	12.0	TDC 3818	£110.26
TDCR32DOC	60	35	20.0	16.0	TDC 3024	£148.26
TDCR40EOC	60	35	25.0	21.0	TDC 3024	£148.26

Unit 14, Foxwood Ind. Park, Foxwood Rd. Chesterfield, Derbyshire S41 9RN

Telephone +44(0)1246 268080 Fax +44(0)1246 260003



12.133

Pulleys & Belts TDC

Belt Guides for Flat & Timing Belts Materials

STD : Polyethylene (U.H.M.W.Pe) Green

TDC

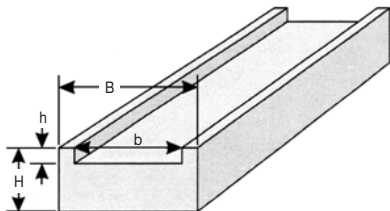

Standard Lengths : 2 Metres

Prices do not include 'C' Profiles.

For other sizes, grades or colours
consult our Technical department.

Pulleys & Belts TDC

DISCOUNTS

1 - 9	List Price
10 - 49	- 20%
50 - 100	- 50%

without C Section Slots

PART NUMBER	Finished Size			h	PRICE PER METRE
	B	H	b		
TDC5BG10	20	15	12	1.5	£47.72
TDC5BG16	28	15	18	1.5	£51.77
TDC5BG20	30	15	22	1.5	£52.79
TDC5BG25	38	20	27	1.5	£63.61
TDC5BG32	42	20	34	1.5	£66.41
TDC5BG50	60	25	52	1.5	£88.98
TDC10BG20	28	15	22	3.5	£51.77
TDC10BG25	38	20	27	3.5	£63.61
TDC10BG32	42	20	34	3.5	£66.41
TDC10BG50	60	25	52	3.5	£88.98
TDC10BG75	87	25	77	3.5	£111.60
TDC10BG100	112	25	102	3.5	£132.53
TDC10BG150	162	25	152	3.5	£174.39
TDC20BG25	38	20	27	6.5	£63.61
TDC20BG32	42	20	34	6.5	£66.41
TDC20BG50	60	25	52	6.5	£88.92
TDC20BG75	87	25	77	6.5	£111.60
TDC20BG100	112	25	102	6.5	£132.53
TDC20BG150	162	25	152	6.5	£174.39

12.134



Unit 14, Foxwood Ind. Park, Foxwood Rd. Chesterfield, Derbyshire S41 9RN
Telephone +44(0)1246 268080 Fax +44(0)1246 260003

Materials **Belt Guides** for Flat & Timing Belts

STD : Polyethylene (U.H.M.W.Pe) Green DIN 2215

ALTERNATIVE : 1000 Black Antistatic

TDC

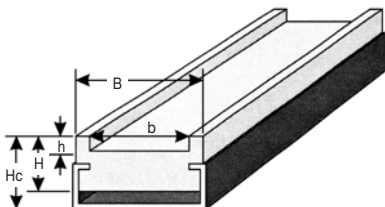

Standard Lengths : 2 Metres

Prices do not include 'C' Profiles.

For other sizes, grades or colours consult our Technical department.

DISCOUNTS

1 - 9	List Price
10 - 49	- 20%
50 - 100	- 50%

with C Section Slots

PART NUMBER	Finished Size					C Profile	PRICE PER METRE
	B	H	b	h	Hc		
TDC5BG10C	20	15	12	1.5	17.5	TDC 2010	£83.97
TDC5BG16C	28	15	18	1.5	18.0	TDC 2812	£87.91
TDC5BG20C	30	15	22	1.5	18.0	TDC 2812	£89.01
TDC5BG25C	38	20	27	1.5	25.0	TDC 3818	£99.85
TDC5BG32C	42	20	34	1.5	25.0	TDC 3818	£102.58
TDC5BG50C	60	25	52	1.5	30.0	TDC 6020	£125.18
TDC10BG20C	28	15	18	3.5	18.0	TDC 2812	£87.91
TDC10BG25C	38	20	27	3.5	25.0	TDC 3818	£99.85
TDC10BG32C	40	20	34	3.5	25.0	TDC 3818	£102.58
TDC10BG50C	60	25	52	3.5	30.0	TDC 6020	£125.18
TDC20BG25C	38	20	27	6.5	28.0	TDC 3818	£99.85
TDC20BG32C	42	20	34	6.5	28.0	TDC 3818	£102.58
TDC20BG50C	60	25	52	6.5	30.0	TDC 6020	£125.18
TDC20BG75C	87	25	77	6.5	30.0	TDC 2175	£147.83
TDC20BG100C	112	25	102	6.5	30.0	TDC 21100	£168.75
TDC20BG150C	162	25	152	6.5	30.0	TDC 21125	£210.64

Unit 14, Foxwood Ind. Park, Foxwood Rd. Chesterfield, Derbyshire S41 9RN

Telephone +44(0)1246 268080 Fax +44(0)1246 260003



12.135

Pulleys & Belts
TDC

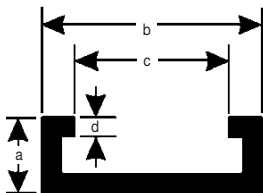

Standard Lengths : 2 Metres

Other lengths and types available on request.

For further information, please contact our Sales department

DISCOUNTS

1 - 9	List Price
10 - 49	- 20%
50 - 100	- 50%

PART NUMBER	Finished Size				Material	PRICE PER METRE
	a	b	c	d		
TDC2010	10	20	10	1.5	Galvanised	£7.27
TDC2010-SS	10	20	10	1.5	Stainless	£25.61
TDC2812	12	28	14	2.0	Galvanised	£14.08
TDC2812-SS	12	28	14	2.0	Stainless	£43.49
TDC3818	18	38	22	2.5	Galvanised	£18.49
TDC3818-SS	18	38	22	2.5	Stainless	£83.11
TDC3024	24	30	20	1.5	Galvanised	£20.77
TDC3024-SS	24	30	20	1.5	Stainless	£53.75
TDC4540	40	45	31	2.0	Galvanised	£28.29
TDC4540-SS	40	45	31	2.0	Stainless	£127.14
TDC6020	20	60	36	2.5	Galvanised	£31.73
TDC6020-SS	20	60	36	2.5	Stainless	£136.94

Materials **Guide Rails** for Simplex Chains

STD : Polyethylene (U.H.M.W.Pe) Green DIN 8187

ALTERNATIVE : Stainless Steel

TDC

TAG V 15

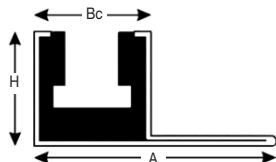

TAG

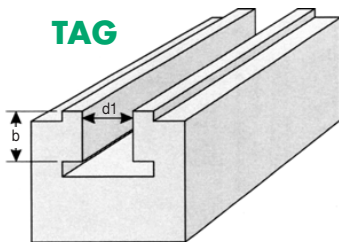

TAG G 14

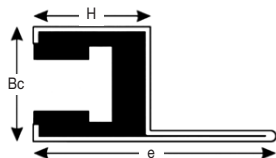

Standard Lengths : 2 Metres

Prices shown are for Galvanised Profile and Polyethylene Chain Guide.

For other sizes, grades or colours consult our Technical department.

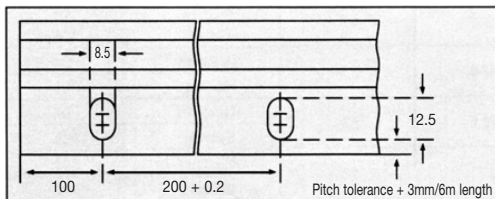

G for Galvanised Steel
S for Stainless Steel

EXAMPLE:

TAG V 15 - TDC 08B

The continuous mounting strip is provided with slotted holes for 8mm diameter screws at 200mm centres, allowing for adjustment.

PART NUMBER	Pitch	d1	Bc	Finished Size b	H	e	A	PRICE PER METRE
TDC06B	3/8" x 7/32"	6.60	30	5.60	24	47	53	£150.72
TDC083	1/2" x 3/16"	8.00	30	4.70	24	47	53	£183.75
TDC084	1/2" x 1/4"	8.00	30	6.30	24	47	53	£183.75
TDC085	1/2" x 1/4"	8.70	30	6.30	24	47	53	£183.75
TDC08B	1/2" x 5/16"	8.70	30	7.60	24	47	53	£150.72
TDC086	5/8" x 1/4"	10.40	30	6.30	24	47	53	£183.75
TDC10B	5/8" x 3/8"	10.40	30	9.50	24	47	53	£150.72
TDC12B	3/4" x 7/16"	12.30	30	11.50	24	47	53	£150.72

Unit 14, Foxwood Ind. Park, Foxwood Rd. Chesterfield, Derbyshire S41 9RN

Telephone +44(0)1246 268080 Fax +44(0)1246 260003



12.137

Pulleys & Belts
TDC

Guide Rails for Simplex Chains Materials

TDC

STD : Polyethylene (U.H.M.W.Pe) Green DIN 8187

GR1 TDC

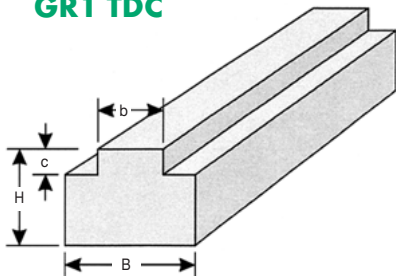

Standard Lengths : 2 Metres

Prices do not include 'C' Profiles.

For other sizes, grades or colours consult our Technical department.

without C Section Slots

DISCOUNTS

1 - 9	List Price
10 - 49	- 20%
50 - 100	- 50%

PART NUMBER	Pitch	b	Finished Size		H	PRICE PER METRE
			B	c		
TDC04-1GR1	6 x 2.8mm	2.6	10	1.0	10	£43.49
TDC05B-1GR1	8 x 3mm	2.8	10	1.5	10	£43.49
TDC053-1GR1	3/8" x 5/32"	3.8	15	1.5	10	£45.08
TDC06B-1GR1	3/5" x 7/32"	5.5	15	1.5	10	£45.08
TDC081-1GR1	1/2" x 3.3mm	3.0	12	1.5	10	£44.05
TDC084-1/1GR1	1/2 x 4.9mm	4.6	17	2.0	10	£45.82
TDC083-1GR1	1/2" x 3/16"	4.7	15	1.6	10	£45.08
TDC084-1/2GR1	1/2" x 1/4"	6.2	20	2.1	10	£46.82
TDC08B-1GR1	1/2" x 5/16"	7.5	20	2.2	10	£46.82
TDC086-1GR1	5/8" x 1/4"	6.3	20	2.6	10	£46.82
TDC10B-1GR1	5/8" x 3/8"	9.3	20	2.6	15	£46.82
TDC12B-1GR1	3/4" x 7/16"	11.3	25	2.4	15	£46.82
TDC16B-1GR1	1" x 17mm	16.5	40	4.3	15	£60.77
TDC20B-1GR1	1 1/4" x 3/4"	19.0	45	4.2	15	£63.26
TDC24B-1GR1	1 1/2" x 1"	24.7	60	5.5	15	£70.82
TDC28B-1GR1	1 3/4" x 31mm	30.1	75	6.8	20	£91.44
TDC32B-1GR1	2" x 31mm	30.1	80	7.7	20	£94.72

Pulleys & Belts TDC

12.138



Unit 14, Foxwood Ind. Park, Foxwood Rd. Chesterfield, Derbyshire S41 9RN
Telephone +44(0)1246 268080 Fax +44(0)1246 260003

Materials **Guide Rails** for Simplex Chains

STD : Polyethylene (U.H.M.W.Pe) Green DIN 8187

TDC

GR1C TDC

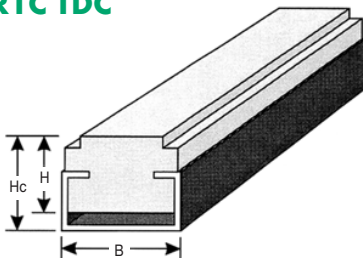

Standard Lengths : 2 Metres

Prices do not include 'C' Profiles.

**For other sizes, grades or colours
consult our Technical department.**

DISCOUNTS

1 - 9	List Price
10 - 49	- 20%
50 - 100	- 50%

with C Section Slots

PART NUMBER	Pitch	Finished Size			C Profile	PRICE PER METRE
		B	H	Hc		
TDC083-10C/A	1/2" x 3/16"	20	10	15	TDC 2010	£83.03
TDC084-10C	1/2" x 1/4"	20	10	15	TDC 2010	£83.03
TDC08B-10C/A	1/2" x 5/16"	20	10	15	TDC 2010	£83.03
TDC083-10C/B	1/2" x 3/16"	17	15	17	TDC 2010	£83.03
TDC085-10C	1/2" x 1/4"	17	15	17	TDC 2010	£83.03
TDC08B-10C/B	1/2" x 5/16"	17	15	17	TDC 2010	£83.03
TDC086-10C	5/8" x 1/4"	17	15	17	TDC 2010	£83.03
TDC10B-10C	5/8" x 3/8"	17	15	17	TDC 2010	£83.03
TDC12B-10C/A	3/4" x 7/16"	20	15	17	TDC 2010	£83.03
TDC12B-10C/B	3/4" x 7/16"	24	15	18	TDC 2812	£83.03
TDC16B-10C	1" x 17mm	24	15	18	TDC 2812	£88.98
TDC20B-10C	1 1/4" x 3/4"	28	15	18	TDC 2812	£90.95
TDC24B-10C	1 1/2" x 1mm	33	25	30	TDC 3818	£105.44
TDC28B-10C	1 3/4" x 31"	38	25	30	TDC 3818	£109.63
TDC32B-10C	2" x 31"	38	25	30	TDC 3818	£109.63

Unit 14, Foxwood Ind. Park, Foxwood Rd. Chesterfield, Derbyshire S41 9RN

Telephone +44(0)1246 268080 Fax +44(0)1246 260003



12.139

Guide Rails for Duplex Chains *Materials*

TDC

STD : Polyethylene (U.H.M.W.Pe) Green DIN 8187

GR2 TDC

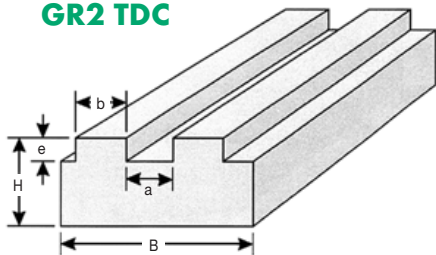

Standard Lengths : 2 Metres

For other sizes, grades or colours
consult our Technical department.

Pulleys & Belts TDC

for Duplex Chains

DISCOUNTS

1 - 9	List Price
10 - 49	- 20%
50 - 100	- 50%

PART NUMBER	Pitch	Finished Size				PRICE PER METRE	
		a	b	B	e		
TDC05B-2	8 x 3mm	2.6	2.8	16	1.5	10	£48.55
TDC06B-2	3/8" x 7/32"	4.6	5.5	25	1.5	10	£51.56
TDC08B-2	1/2" x 5/16"	6.2	7.5	35	2.2	10	£51.56
TDC10B-2	5/8" x 3/5"	7.0	9.3	40	2.6	10	£51.56
TDC12B-2	3/4" x 7/16"	7.8	11.3	45	2.4	10	£51.56
TDC16B-2	1" x 17mm	15.0	16.5	48	4.3	15	£51.56
TDC20B-2	1 1/4" x 3/4"	17.0	19.0	55	4.2	15	£71.30
TDC24B-2	1 1/2" x 1"	22.6	24.7	72	5.5	20	£92.40
TDC28B-2	1 3/4" x 31mm	28.8	30.1	89	6.8	25	£119.13
TDC32B-2	2" x 31mm	27.8	30.1	88	7.7	30	£133.60

12.140



Unit 14, Foxwood Ind. Park, Foxwood Rd. Chesterfield, Derbyshire S41 9RN
Telephone +44(0)1246 268080 Fax +44(0)1246 260003

Materials **Guide Rails** for Triplex Chains

STD : Polyethylene (U.H.M.W.Pe) Green DIN 8187

TDC

GR3 TDC

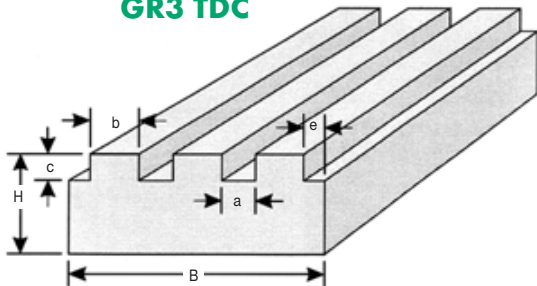

Standard Lengths : 2 Metres

**For other sizes, grades or colours
consult our Technical department.**

Pulleys & Belts TDC

DISCOUNTS

1 - 9	List Price
10 - 49	- 20%
50 - 100	- 50%

for Triplex Chains

PART NUMBER	Pitch	a	b	e	Finished Size B	c	H	PRICE PER METRE
TDC06B-3	3/8" x 7/32"	4.7	5.5	4.55	35	1.5	10	£57.91
TDC08B-3	1/2" x 5/16"	6.5	7.4	4.40	44	2.2	10	£60.91
TDC10B-3	5/8" x 3/8"	7.4	9.2	5.30	53	2.6	10	£63.99
TDC12B-3	3/4" x 7/16"	8.9	11.2	5.90	62	3.0	10	£66.93
TDC16B-3	1" x 17mm	15.4	16.5	11.85	104	3.5	15	£99.05

Unit 14, Foxwood Ind. Park, Foxwood Rd. Chesterfield, Derbyshire S41 9RN

Telephone +44(0)1246 268080 Fax +44(0)1246 260003



12.141

Guide Rails for Simplex Chains Materials

TDC

STD : Polyethylene (U.H.M.W.Pe) Green DIN 8187

GL1b TDC

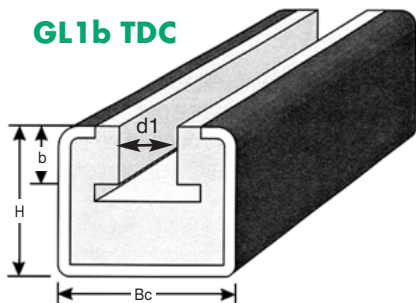

Standard Lengths : 2 Metres

Prices do not include 'C' Profiles.

For other sizes, grades or colours consult our Technical department.

Pulleys & Belts TDC

for Simplex Chains

DISCOUNTS

1 - 9	List Price
10 - 49	- 20%
50 - 100	- 50%

PART NUMBER	Pitch	d1	Finished Size Bc	b	H	PRICE PER METRE
TDC053-10U	3/8" x 5/32"	6.6	30	3.8	24	£100.24
TDC06B-10U	3/8" x 7/32"	6.6	30	5.6	24	£100.24
TDC083-10U	1/2" x 3/16"	8.0	30	4.7	24	£100.24
TDC084-10U	1/2" x 1/4"	8.0	30	6.3	24	£100.24
TDC085-10U	1/2" x 1/4"	8.7	30	6.3	24	£100.24
TDC08B-10U	1/2" x 5/16"	8.7	30	7.6	24	£100.24
TDC086-10U	5/8" x 1/4"	10.4	30	6.3	24	£100.24
TDC10B-10U	5/8" x 3/8"	10.4	30	9.5	24	£100.24
TDC12B-10U	3/4" x 7/16"	12.3	30	11.5	24	£100.24
TDC16B-10U	1" x 17mm	16.1	45	16.5	40	£135.98
TDC20B-10U	1 1/4" x 3/4"	19.3	45	17.5	40	£135.98

12.142



Unit 14, Foxwood Ind. Park, Foxwood Rd. Chesterfield, Derbyshire S41 9RN

Telephone +44(0)1246 268080 Fax +44(0)1246 260003

Materials **Guide Rails** for Simplex Chains

STD : Polyethylene (U.H.M.W.Pe) Green DIN 8187

TDC

GL1X TDC

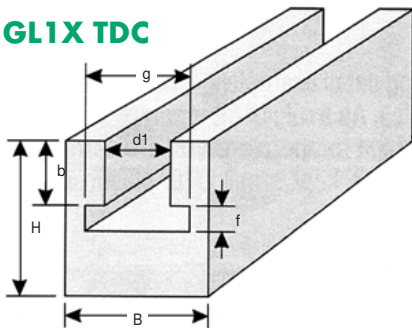

Standard Lengths : 2 Metres

Prices do not include 'C' Profiles.

**For other sizes, grades or colours
consult our Technical department.**

DISCOUNTS

1 - 9	List Price
10 - 49	- 20%
50 - 100	- 50%

for Simplex Chains

PART NUMBER	Pitch	d1	g	Finished Size			H	PRICE PER METRE
				B	f	b		
TDC053-1GL1X	3/8" x 5/32"	6.6	9.3	20	4.2	3.8	25	£60.91
TDC06B-1GL1X	3/8" x 7/32"	6.6	9.3	20	4.3	5.6	25	£60.91
TDC083-1GL1X	1/2" x 3/16"	8.0	10.8	20	3.6	4.7	25	£60.91
TDC084-1GL1X	1/2" x 1/4"	8.0	11.8	24	4.9	6.3	30	£68.49
TDC085-1GL1X	1/2" x 1/4"	8.7	12.8	24	5.0	6.3	30	£68.49
TDC08B-1GL1X	1/2" x 5/16"	8.7	12.8	24	5.1	7.6	30	£68.49
TDC086-1GL1X	5/8" x 1/4"	10.4	15.4	30	5.4	6.3	30	£75.21
TDC10B-1GL1X	5/8" x 3/8"	10.4	15.4	30	5.3	9.5	35	£80.46
TDC12B-1GL1X	3/4" x 7/16"	12.3	16.9	40	6.0	11.5	35	£93.12
TDC16B-1GL1X	1" x 17mm	16.1	24.4	40	9.9	16.5	45	£106.68
TDC20B-1GL1X	1 1/4" x 3/4"	19.3	27.5	50	11.8	19.4	50	£130.97
TDC24B-1GL1X	1 1/2" x 1"	25.7	36.5	60	14.9	25.2	60	£168.82
TDC28B-1GL1X	1 3/4" x 31mm	28.3	41.5	60	18.1	30.8	70	£188.60
TDC32B-1GL1X	2" x 31mm	28.3	41.5	70	22.2	30.8	75	£225.18

Unit 14, Foxwood Ind. Park, Foxwood Rd. Chesterfield, Derbyshire S41 9RN

Telephone +44(0)1246 268080 Fax +44(0)1246 260003



12.143

Pulleys & Belts TDC